

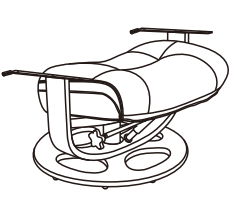

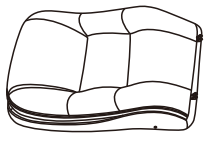

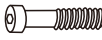

Recliner Assembly Instructions

Please read the assembly instructions thoroughly and assemble this recliner per the assembly instructions. Please note that using an incorrect assembly method may damage the structure of this recliner!

Recliner Parts & Hardware

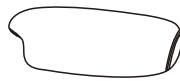
Part#	Description	Quantity	Picture
1	Large Wooden Seat Base Central Post, Wooden Seat Frame(larger), Metal Arm Rest Frame & Seat Cushion	1	
2	Back Cushion	1	
3	2-1/4" Machine Screws(φ8mm)	2	
4	Nuts	2	
5	1" Joint Screws(φ8mm)	2	
6A	Right Arm Pad	1	
6B	Left Arm Pad	1	
7	1" Machine Screws(φ1/4")	4	
14	Wrenches	2	

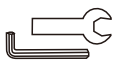
TWO PEOPLE ARE RECOMMENDED FOR BACK CUSHION ASSEMBLY!

Step 1: Place the following recliner parts on the floor, make sure there is a protective surface to protect the components during assembly.

- 1). The pre-assembled Large Wooden Seat Base, Central Post, Large Wooden Seat Frame, Metal Arm Rest Frame and Seat Cushion
- 2). Back Cushion
- 3). 6A Right Arm Pad and 6B Left Arm Pad

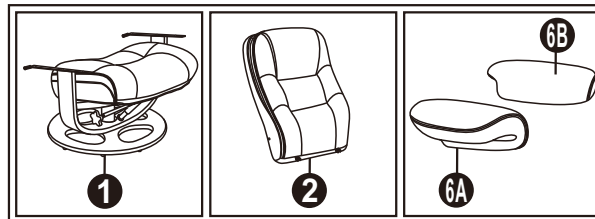

Step 3: After assembling the back cushion to the arms, loosen the tension adjustment knob at the right side of the recliner and slide the seat forward. While pulling slightly on the back cushion from behind the recliner, align the holes of each bracket on the bottom of the Back Cushion (2) to the metal rings on the rear of the Seat Cushion (1). Insert the 1" Joint Screws (5) through the metal rings in the Nuts (4) and tighten the screws.

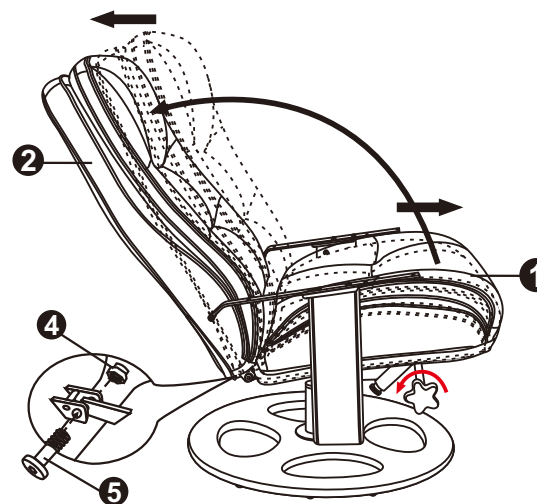



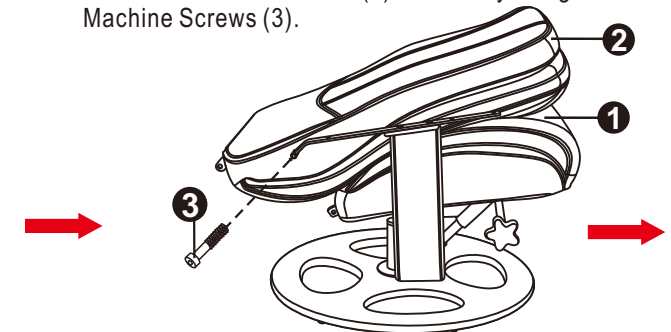



Step 2: Attach the Back Cushion (2) onto the pre-assembled Large Wood Seat Base, Central Post, Large Wooden Seat Frame, Metal Arm Rest Frame & Seat Cushion (1). Align the holes of the Metal Arm Rest Frame (1) to both sides of the Back Cushion (2). Fasten by using 2-1/4" Machine Screws (3).



Step 4: Attach the Right Arm Pad (6A) and Left Arm Pad (6B) onto the Metal Arm Rest Frame (1) using 1" Machine Screws (7). Do not tighten screws fully until you have completed assembly.

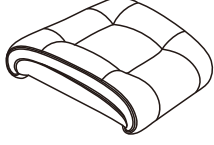
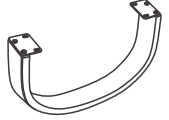

Ottoman Parts & Hardware List

Part#	Description	Quantity	Picture
7	1" Machine Screws($\phi 1/4"$)	4	
8	1-5/8" Machine Screws($\phi 8\text{mm}$)	4	
9	Spring Washers	4	
10	Flat Washers	4	
11	Ottoman Cushion	1	
12	Smaller Wooden Ottoman Frame	1	
13	Smaller Wooden Ottoman Base	1	
14	Wrenches	1	

NOTE: Before using your recliner, ensure that all the screws are tightened fully for safety. Keep the allen wrenches and check all screws periodically to ensure these remain tightly fastened.

Ottoman Assembly Instructions

Step 1: Place the following ottoman parts on the floor:

- 11). Ottoman Cushion
- 12). Smaller Wooden Ottoman Frame
- 13). Smaller Wooden Ottoman Base

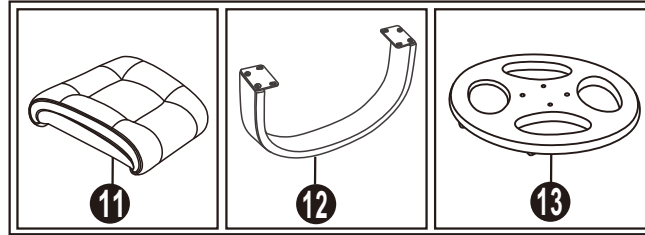

Step 3: Attach the Smaller Wooden Ottoman Base (13) on top of the Smaller Wooden Ottoman Frame (12). Attach by using 1-5/8" Machine Screws (8) with Spring Washers (9) and Flat Washers (10). Tighten all screws. Turn the ottoman upright.

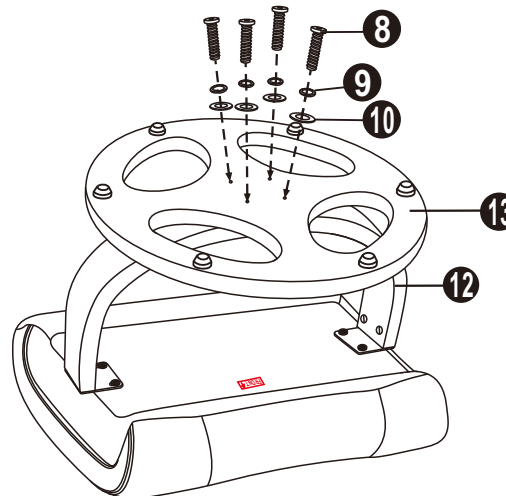

Step 2: Turn the Ottoman Cushion (11) upside down on the floor and attach the Wooden Ottoman Frame (12) to the Ottoman Cushion (11) by using 1" Machine Screws (7). Tighten all screws.

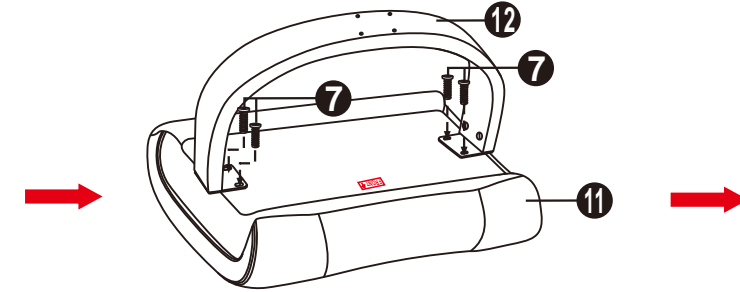

OPERATING INSTRUCTIONS

While seated in the Recliner, reach to the right side of the Recliner and find the adjustment knob. Turn the adjustment knob counter-clockwise and the Back Seat Cushion will recline back. To lock the Back Seat Cushion into desired position, turn the adjustment knob clockwise until tightened.

